

PIPES PVDF Plain Ends

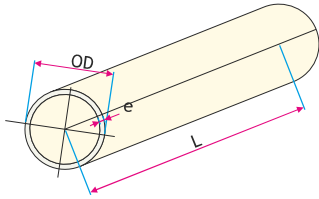

PN — 10

SIZE OD	THICKNESS e	LENGTH L (mm)
63 mm	2.0	5000
75 mm	2.3	5000
90 mm	2.8	5000
110 mm	3.4	5000
125 mm	3.9	5000
140 mm	4.3	5000
160 mm	4.9	5000
180 mm	5.5	5000
200 mm	6.2	5000
225 mm	6.9	5000

PN — 16

SIZE OD	THICKNESS e	LENGTH L (mm)
15 mm	1.9	5000
20 mm	1.9	5000
25 mm	1.9	5000
32 mm	2.4	5000
40 mm	2.4	5000
50 mm	3.0	5000
63 mm	3.0	5000
75 mm	3.6	5000
90 mm	4.3	5000
110 mm	5.3	5000
125 mm	6.0	5000
140 mm	6.7	5000
160 mm	7.7	5000

PIPES PP / ISO . PP / PPH Plain Ends

PP / ISO. PP / PPH Pipes Manufactured as per DIN 8077

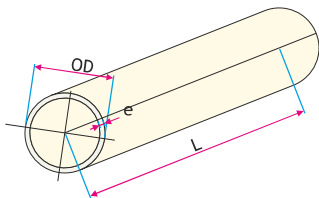

Size DN	Wall Series NORMAL PRESSURES			
	PN 2.5	PN 4	PN 6	PN 10
	e mm	e mm	e mm	e mm
20			1.8	2.5
25			1.8	2.7
32			2.0	3.0
40			2.3	3.7
50	1.8	2.0	2.9	4.6
63	1.8	2.5	3.6	5.8
75	1.9	2.9	4.3	6.9
90	2.2	3.5	5.1	8.2
110	2.7	4.3	6.3	10.0

Size DN	Wall Series NORMAL PRESSURES			
	PN 2.5	PN 4	PN 6	PN 10
	e mm	e mm	e mm	e mm
125	3.1	4.9	7.1	11.4
140	3.5	5.4	8.0	12.8
160	3.9	6.2	9.1	14.6
180	4.4	7.0	10.2	16.4
200	4.9	7.7	11.4	18.2
225	5.5	8.7	12.8	20.5
250	6.1	9.7	14.2	22.8
280	6.9	10.8	15.9	25.5
315	7.7	12.2	17.9	28.7

OD = Outside diameter of pipe
e = Wall thickness of pipe
Standard Length of pipe is 3000 mm

COUPLINGS PP / ISO. PP / PPH / PVDF ENDS : SOCKET WELD

Dimensional Table

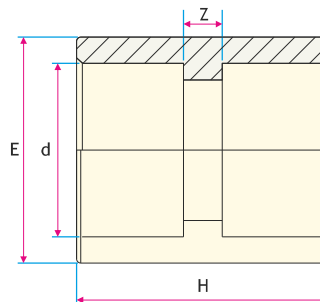

SIZE (OD)	E	d	H	Z
20 mm	31	20	35	7
25 mm	36	25	39	7
32 mm	44	32	43	7
50 mm	66	50	54	8
63 mm	82	63	62	8
75 mm	92	75	81	10
90 mm	112	90	81	10
110 mm	135	110	96	12
160 mm	188	160	120	15

STUB ENDS PVDF ENDS : BUTT WELD – LONG NECK

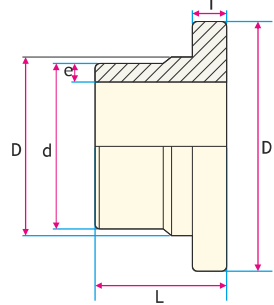

Dimensional Table

SIZE OD/d	e	D	D1	L	T
20 mm	2.5	26	45	30	6
25 mm	2.5	31	55	30	7
32 mm	3.0	36	60	30	7
40 mm	3.0	49	75	50	8
50 mm	3.5	59	80	50	8
63 mm	3.5	69	95	50	9
75 mm	4.0	84	119	50	10
90 mm	4.5	99	130	80	11
110 mm	6.0	119	158	80	12
140 mm	7.5	150	188	80	15
160 mm	8.5	170	205	118	16
180 mm	16.4	188	211	80	20
200 mm	18.2	213	247	80	20
225 mm	19.0	235	269	100	20
280 mm	25.0	291	321	100	25
315 mm	28.0	330	380	95	25
400 mm	25.0	400	460	90	27
450 mm	27.0	450	515	92	28

STUB ENDS PP / ISO. PP/ PPH / PVDF ENDS : BUTT WELD – SHORT NECK

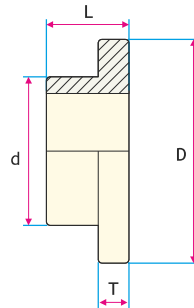

Dimensional Table

SIZE (OD)	d	D	L	T
20 mm	20	37	25	8
25 mm	25	54	30	8
32 mm	32	60	30	8
50 mm	50	75	30	10
63 mm	63	95	30	12
75 mm	75	105	30	14
90 mm	90	123	30	14
110 mm	110	155	30	14
160 mm	160	203	38	18
225 mm	225	268	42	25

FLANGES PP / ISO. PP/ PPH / PVDF SLIP ON & PIPE BORE

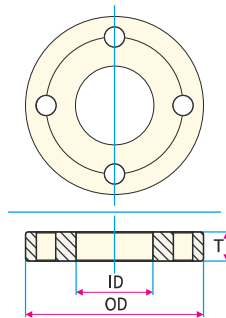

Dimensional Table

SIZE IN PIPE OD	SIZE IN NB	ID	OD	T
20	15	20	95	16
25	20	25	114	16
32	25	32	120	17
50	40	50	140	17
63	50	63	165	21
75	65	75	199	22
90	80	90	199	22
110	100	110	230	22
140	125	140	254	25
160	150	160	305	25
225	200	225	343	30
315	300	315	483	30

NOTE : For slip on flanges ID may vary.

CONCENTRIC REDUCERS PP / ISO. PP/ PPH / PVDF ENDS : BUTT WELD

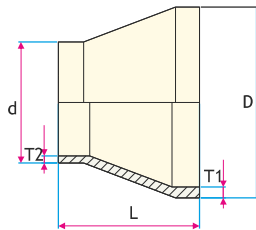

Dimensional Table

SIZE IN PIPE OD (D-d)	SIZE IN NB	T1	T2	L
32 X 20	25 X 15	3.5	2.5	55.0
32 X 25	25 X 20	3.5	2.5	55.0
40 X 32	32 X 25	3.8	3.5	45.0
50 X 40	40 X 32	5.0	4.0	58.0
50 X 32	40 X 25	5.0	3.5	60.0
50 X 20	40 X 15	5.0	2.5	60.0
63 X 32	50 X 25	6.0	3.5	70.0
63 X 50	50 X 40	6.0	5.0	70.0
75 X 40	65 X 32	7.0	3.8	60.0
75 X 50	65 X 40	7.0	5.0	50.0
75 X 63	65 X 50	7.0	6.0	50.0
90 X 50	75 X 40	9.0	5.0	75.0
90 X 63	75 X 50	9.0	6.0	75.0
90 X 32	75 X 25	9.0	3.0	145.0
110 X 90	100 X 75	10.0	9.0	75.0
110 X 63	100 X 50	10.0	6.0	120.0
160 X 110	100 X 150	10.0	15.0	120.0
160 X 125	150 X 125	15.0	11.4	100.0
160 X 140	150 X 125	15.0	13.0	100.0
315 X 225	300 X 200	13.0	18.0	130.0
400 X 280	400 X 250	17.0	25.0	145.0
450 X 315	450 X 300	20.0	26.0	145.0

EQUAL TEES PP / ISO. PP/ PPH / PVDF ENDS : SOCKET WELD

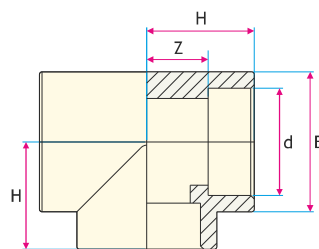

Dimensional Table

SIZE (OD)	E	d	H	Z
20 mm	26	20	29	17
25 mm	32	25	34	20
32 mm	42	32	46	24
40 mm	53	40	40	22
50 mm	63	50	61	30
63 mm	78	63	62	36
75 mm	91	75	75	43
90 mm	107	90	88	53
110 mm	128	110	104	69
160 mm	190	160	140	100

ELBOWS PP / ISO. PP/ PPH / PVDF ENDS : SOCKET WELD

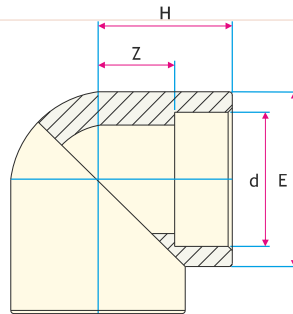

Dimensional Table

SIZE (OD)	E	d	H	Z
20 mm	26	20	27	15
25 mm	33	25	32	16
32 mm	44	32	38	20
40 mm	53	40	40	22
50 mm	67	50	49	25
63 mm	83	63	64	36
75 mm	91	75	75	43
90 mm	111	90	89	57
110 mm	136	110	106	69
160 mm	190	160	162	122

STUB ENDS PP / ISO. PP/ PPH / PVDF ENDS: SOCKET WELD

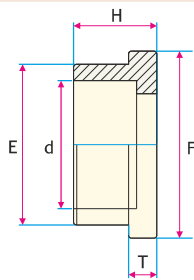

Dimensional Table

SIZE (OD)	E	d	H	F	T
25mm	33	25	23	44	7
32 mm	41	32	26	50	10
50 mm	63	50	35	77	12
63 mm	76	63	37	90	14
90 mm	109	90	47	125	16
110 mm	131	110	55	150	18
160 mm	188	160	70	216	18
200 mm	228	200	90	275	22

EQUAL TEE PVDF BUTT WELD ENDS

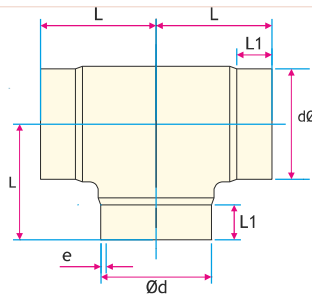

Dimensional Table

d	PN	e	L	L1
20 mm	16	1.9	38	20
25 mm	16	1.9	42	20
32 mm	16	2.4	46	20
40 mm	16	2.4	51	20
50 mm	16	3.0	58	20
63 mm	16	3.0	66	20
75 mm	16	3.6	78	20
90 mm	16	4.3	90	20
110 mm	16	5.3	110	20
160 mm	16	7.7	160	25

ELBOW 90° PVDF BUTT WELD ENDS

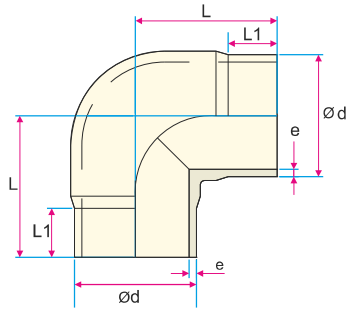

Dimensional Table

d	PN	e	L	L1
20 mm	16	1.9	38	16
25 mm	16	1.9	42	16
32 mm	16	2.4	46	18
40 mm	16	2.4	51	18
50 mm	16	3.0	58	20
63 mm	16	3.0	66	20

BENDS 90° PVDF BUTT WELD ENDS

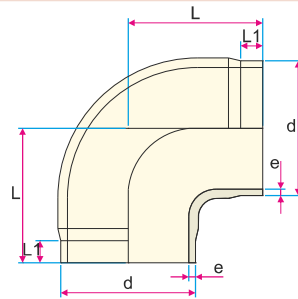

Dimensional Table

d	PN	e	L	L1
75 mm	16	3.6	75	16
90 mm	16	4.3	90	20
110 mm	16	5.3	110	20
160 mm	16	7.7	160	25

ELBOW 45° PVDF / PP / ISO. PP / PPH / SOCKET WELD ENDS

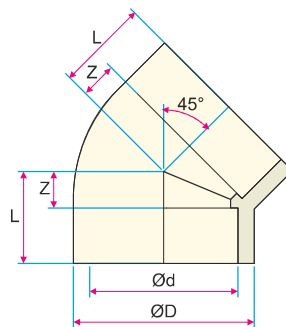

Dimensional Table

SIZE (OD)	PN	D	L	Z
20 mm	16	31	21	7
25 mm	16	36	24	8
32 mm	16	44	28	10
40 mm	16	53	33	13
50 mm	16	64	36	13
63 mm	16	82	43	16
75 mm	16	93	51	20
90 mm	16	114	58	23
110 mm	16	134	68	27